

BD Adjustable Track Bar w/Bracket

Dodge 2500-3500 4WD Models	1994-2002
Dodge 1500 4WD Model	1994-2001









P/N# 1032011-F

PLEASE READ ALL INSTRUCTIONS BEFORE INSTALLATION

BD Engine Brake Inc.
 Plant Address: 33541 MacLure Rd. Abbotsford, BC, Canada V2S 7W2
 U.S. Shipping Address: 88-446 Harrison St, Sumas, WA 98295 U.S. Mailing Address: P.O. Box 231, Sumas, WA 98295
 Phone: 604-853-6096 | Fax: 604-853-8749 | Internet: www.bd-power.com

KIT CONTENTS:

Please check to make sure that you have all the parts listed in this kit **before** you start the disassembly of your truck.

Kit # 1032012		
1302030-1F	1302030-2F	1302030-4
		
<i>Trackbar, Driver's Side</i>	<i>Trackbar, Passenger's Side (Left Hand Thread)</i>	<i>Threaded Connector</i>
Qty: 1	Qty: 1	Qty: 1
1302031	1302032	1302033
		
<i>Jam Nut 1 3/8NF</i>	<i>Jam Nut 1 3/8NF (Left Hand Thread -Arrow)</i>	<i>Polyurethane Bushing Set</i>
Qty: 1	Qty: 1	Qty: 1
1302057	1302056	1302066
		
<i>Grease Nipple (M6)</i>	<i>Grease Nipple 90° (M6)</i>	<i>Grease Nipple 45°</i>
Qty: 1	Qty: 1	Qty: 1

BD Engine Brake Inc.



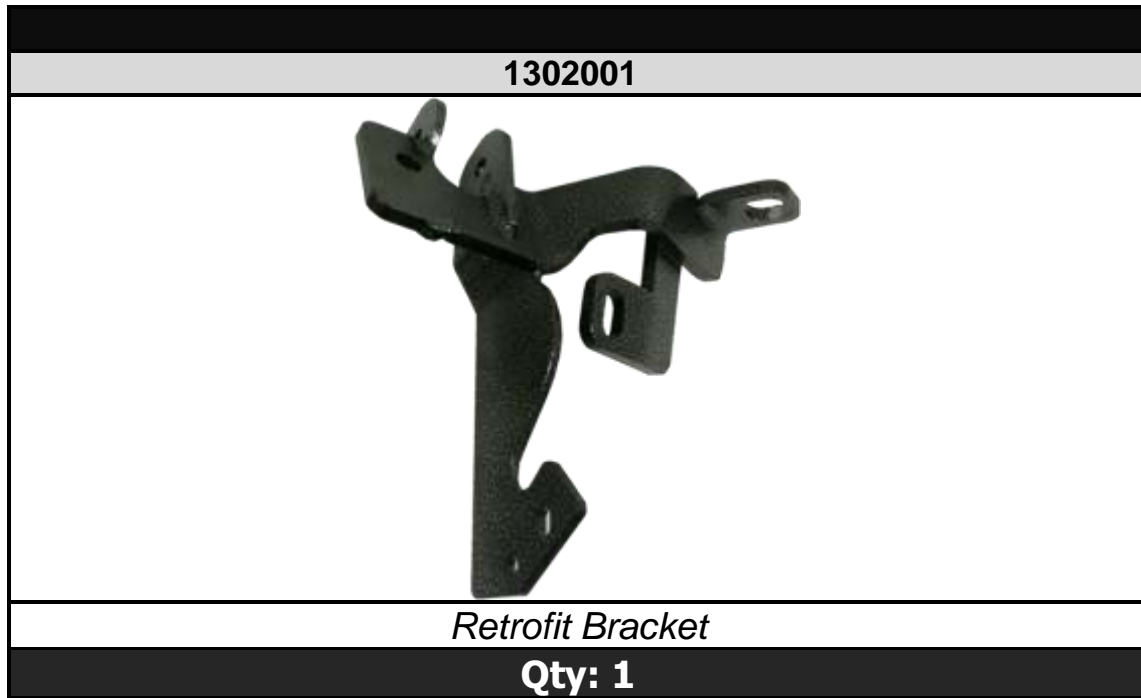

Plant Address: 33541 MacLure Rd. Abbotsford, BC, Canada V2S 7W2

U.S. Shipping Address: 88-446 Harrison St, Sumas, WA 98295 U.S. Mailing Address: P.O. Box 231, Sumas, WA 98295

Phone: 604-853-6096 | Fax: 604-853-8749 | Internet: www.bd-power.com

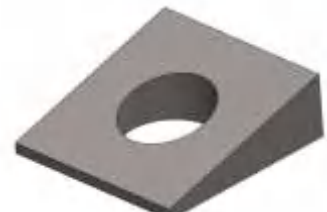

1302011 – Hardware Kit

1302043	1302044	1302046	1302045	1302047
				
<i>5/8NF x 2.5" Bolt</i>	<i>5/8" Washer</i>	<i>5/8 Lock washer</i>	<i>5/8NF Locknut</i>	<i>1/2NC x 5" Bolt</i>
Qty: 1	Qty: 2	Qty: 1	Qty: 1	Qty: 1
1302059	1302049	1302050	1302051	1302052
				
<i>Wedge Block</i>	<i>1/2NC LockNut</i>	<i>1/2" Lock Washer</i>	<i>5/16NC x 2" Bolt</i>	<i>5/16 Washer</i>
Qty: 2	Qty: 2	Qty: 2	Qty: 2	Qty: 4

1302053	1302041	1302054	1302055	1302012	1302040Z
					
<i>5/16NC Locknut</i>	<i>5/16" Collar</i>	<i>5/16 Lock Washer</i>	<i>1/2NC x 4.5" Bolt</i>	<i>Plate Washer</i>	<i>1/2" Collar</i>
Qty: 2	Qty: 2	Qty: 2	Qty: 1	Qty: 1	Qty: 1
1302048	1302042Z	1302034	1302035	1302036	
					
<i>1/2" Washer</i>	<i>Tapered Insert</i>	<i>M14 x 2.0 x 75MM</i>	<i>M14 Washer</i>	<i>M14 x 2.0 Lock Nut</i>	
Qty: 2	Qty: 1	Qty: 1	Qty: 2	Qty: 1	

Welcome

Thank you for purchasing a BD track bar retro fit kit. This manual is divided into different areas to assist you with your installation and operation of your adjustable track bar kit.

This product is a replacement for the factory track bar. If the securing mounts have any signs of wear they should be fixed before installing the track bar. You will be reusing the factory bolts, if these bolts show any wear, replace them.

Installation should occur on a vehicle properly secured to prevent rolling.

Application of a marine grade lubricant at regular chassis lube intervals will promote bushing life.

Required Tools

- Sharpie or Metal Marker
- Bearing Grease
- Anti-Seize Paste
- 7mm Wrench
- 9mm Wrench
- 13mm Socket or Wrench
- 18mm Socket or Wrench
- 22mm Wrench and Socket
- 18mm Socket or Wrench
- ¾" Wrench and Socket
- ½" Wrench and Socket
- 15/16" Socket
- 2 1/16" Open End Wrench and/or Large Crescent Wrench
- Large Crescent Wrench (>1.5")
- Torque Wrench (250 lbs-ft)
- ¾" Drill Bit
- ½" Drill Bit
- Center Punch
- Electric or Pneumatic Drill
- Tape Measure

If you have a vehicle that is manufactured between September 1993 and January 1994 you will need to complete some specific instructions for your vehicle.

BD Engine Brake Inc.

Plant Address: 33541 MacLure Rd. Abbotsford, BC, Canada V2S 7W2

U.S. Shipping Address: 88-446 Harrison St, Sumas, WA 98295 U.S. Mailing Address: P.O. Box 231, Sumas, WA 98295

Phone: 604-853-6096 | Fax: 604-853-8749 | Internet: www.bd-power.com

Vehicles manufacture between September 1994 and January 1994

These particular vehicles have a very small mounting hole in the ear that connects the track bar mount to the frame. If you have one of the vehicles you will need to enlarge the mounting hole.



Drill this hole to 5/8" then using SNAP ON Tool # R121 you will need to ream the larger taper in to the hole. Along this process test the tapered bushing to ensure a sound fit. Repeat this process.

Maintenance

Grease bushings at regular oil change intervals for optimal protection of bearing from wear and contamination due to environment. To grease use a high quality marine grade bushing grease.

Retrofit Bracket Installation



VEHICLE SHOULD BE SAFELY SECURED BEFORE INSTALLATION.

THIS TRACK BAR SHOULD BE INSTALLED AT A SHOP THAT CAN PERFORM A FRONT END ALIGNMENT

Lift and support front of truck. Be sure to block the wheels to prevent the vehicle from rolling.

Please note that the front suspension is loaded and not hanging free.

As well if you want to remove the driver's side front wheel it will allow better access.



Remove stock track bar. Using an 18mm socket remove the passenger's side bolt.

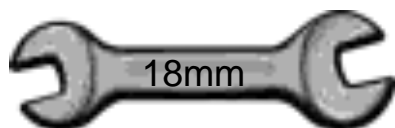

On the driver's side mount you will need to remove the cotter pin. Then using a 21mm wrench, loosen and remove the castle nut.



BD Engine Brake Inc.

Plant Address: 33541 MacLure Rd. Abbotsford, BC, Canada V2S 7W2

U.S. Shipping Address: 88-446 Harrison St, Sumas, WA 98295 U.S. Mailing Address: P.O. Box 231, Sumas, WA 98295

Phone: 604-853-6096 | Fax: 604-853-8749 | Internet: www.bd-power.com

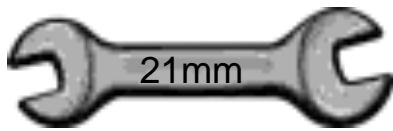

Finally using a joint fork pry the track bar away from the frame mount.

Be careful not to damage the frame mount.

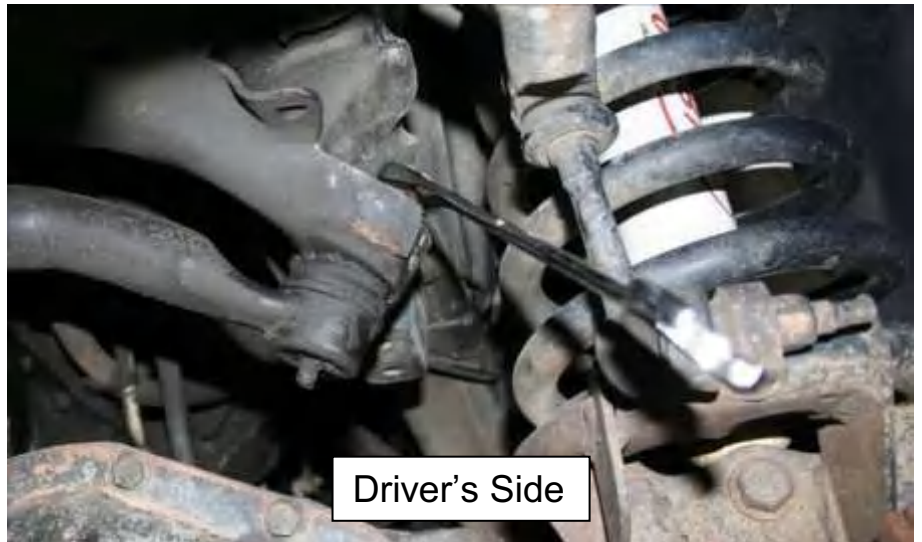

BD Engine Brake Inc.

Plant Address: 33541 MacLure Rd. Abbotsford, BC, Canada V2S 7W2

U.S. Shipping Address: 88-446 Harrison St, Sumas, WA 98295 U.S. Mailing Address: P.O. Box 231, Sumas, WA 98295

Phone: 604-853-6096 | Fax: 604-853-8749 | Internet: www.bd-power.com

You should be able to remove the track bar now.

Using a bristle brush, clean out the inside of the driver's side track bar mount.

As well, clean the lower face around the hole.



Clean the outside frame rail where the retrofit bracket will mount.

Locate the existing hole just below the ground strap. You will need to use a 3/4" drill bit and thru drill this hole to through the other side of the frame.

The drill hole must be level.

Once through, deburr the exit hole.

BE CAREFUL NOT TO DAMAGE ANYTHING ON THE INSIDE OF THE FRAME.



3/4" 



Remove brake line support bracket and bolt from the rear of the cross member.

Bend brake line out of the immediate area.

DO NOT KINK BRAKE LINE.

This cross member supports the left and right frame rails, and travels underneath the motor.



Insert tapered insert (#1302042Z) into the driver's side track bar mounting hole.

If you grease the outside of the insert, it should stay in place.

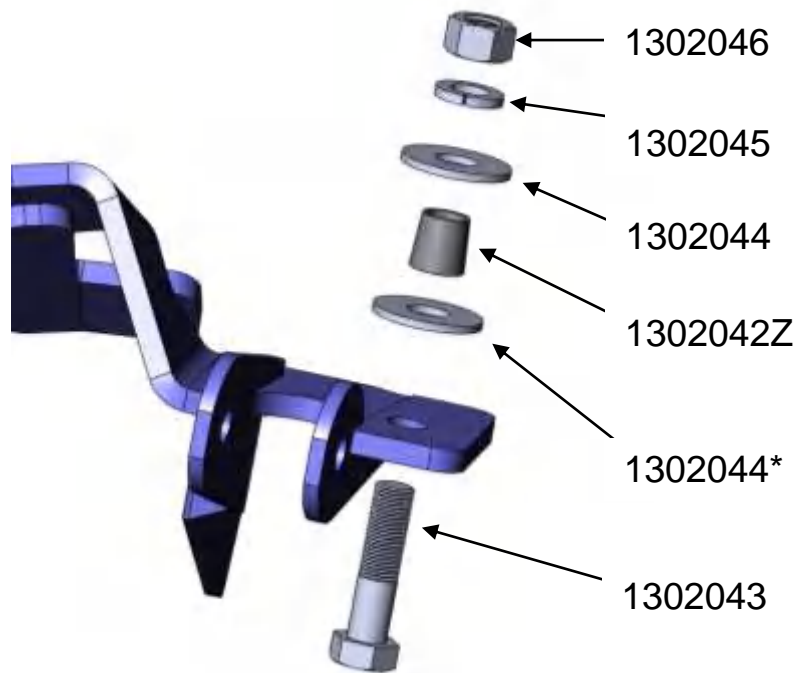

Place the retrofit bracket (#1302001) against the driver's side frame rail, as seen in the picture.

Insert the main 5/8" support bolt (#132043) followed by all the applicable hardware (see below picture).



**DO NOT TIGHTEN
HARDWARE, LEAVE
LOOSE.**

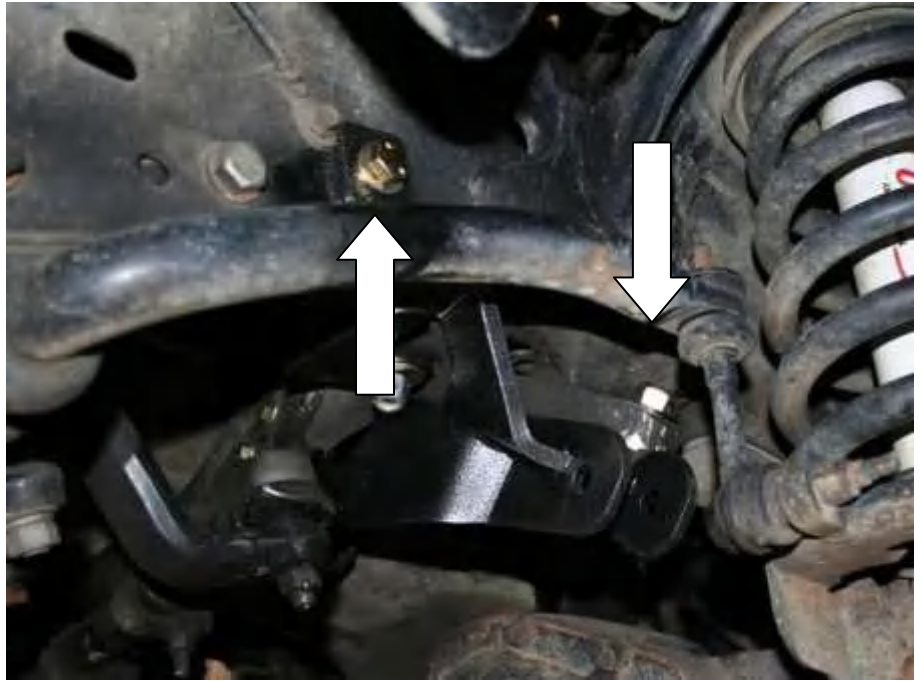

* You will only need to use the second 1302044 washer if the weld line is very large on the driver's side factory track bar mounting face.

This washer will keep the retrofit bracket square. If the weld line is not thicker than the washer **DO NOT USE IT.**

BD Engine Brake Inc.

Plant Address: 33541 MacLure Rd. Abbotsford, BC, Canada V2S 7W2

U.S. Shipping Address: 88-446 Harrison St, Sumas, WA 98295 U.S. Mailing Address: P.O. Box 231, Sumas, WA 98295

Phone: 604-853-6096 | Fax: 604-853-8749 | Internet: www.bd-power.com

In the picture this weld line is not substantial big enough to use the washer.



You can now insert the 1/2" x 4.5" (#1302055) bolt and hardware securing the retrofit bracket to side of the frame.



Insert the collared tube (#1302040Z) so the collar faces the inside of the frame rail.

TIGHTEN ONLY A COUPLE THREADS.

Note the plate washer (#1302012) is used to allow fitment to various frame styles throughout the years. When tightening you will need to use a crescent wrench to keep this square.

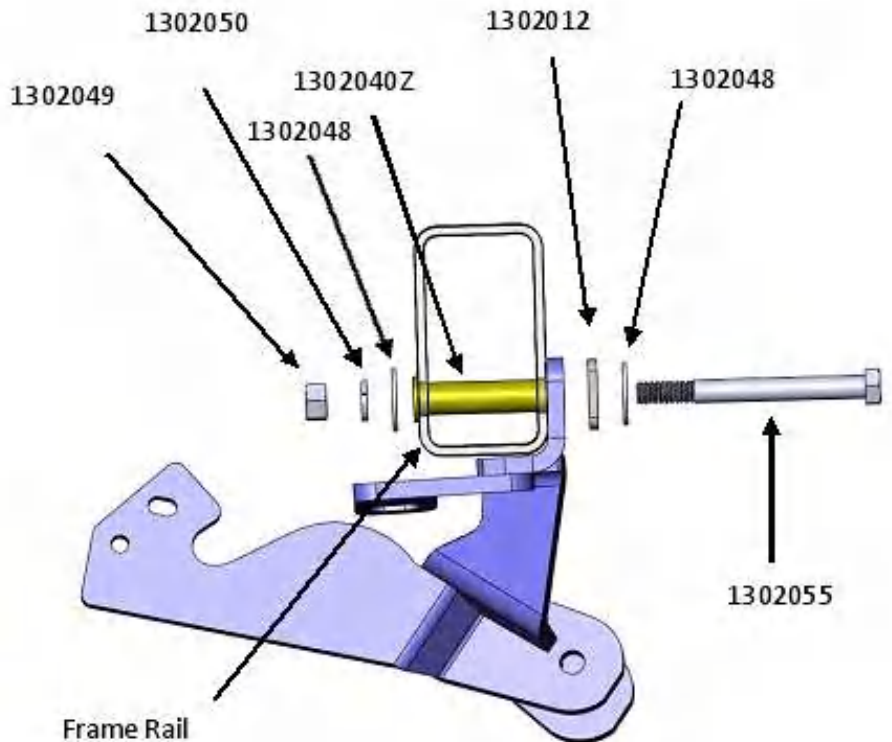

With the retrofit bracket, loosely in place, we can now focus on the rear of the cross member.

Press the retrofit bracket against the rear of the cross member.

The existing brake line hole should be some center in the upper oblong hole. Using a metal marker, mark the center of the second circular hole.



Now remove the retrofit bracket.

Using a 5/16" drill bit, drill the existing hole larger completely through the cross member.

Using a center punch, punch the center of the marked hole.

Now drill completely through the cross member.

Each hole must be level.

You should now have two 5/16" thru holes, through the cross member.

Using the 1/2" drill bit, drill front side of cross member.

Do not drill through to the rear of the cross member.

You must deburr/chamfer each hole as the compression sleeve is over sized and will not fit a 1/2" hole.

Deburr each hole.



5/16"  **1/2"** 

BD Engine Brake Inc.

Plant Address: 33541 MacLure Rd. Abbotsford, BC, Canada V2S 7W2

U.S. Shipping Address: 88-446 Harrison St, Sumas, WA 98295 U.S. Mailing Address: P.O. Box 231, Sumas, WA 98295

Phone: 604-853-6096 | Fax: 604-853-8749 | Internet: www.bd-power.com

Now re-install the retrofit bracket.

Install the large 5/8" bolt first, then the side mount 1/2" bolt and then finally we can install the cross member bolts.

Install the cross member collared units so that the collars are towards the front of the vehicle. Then the 5/16" bolts (#1302051), along with the washers, lock washers and nuts.



In some applications the cross member may be thicker in that case you can leave out the lock washers. Remember to keep everything loose.

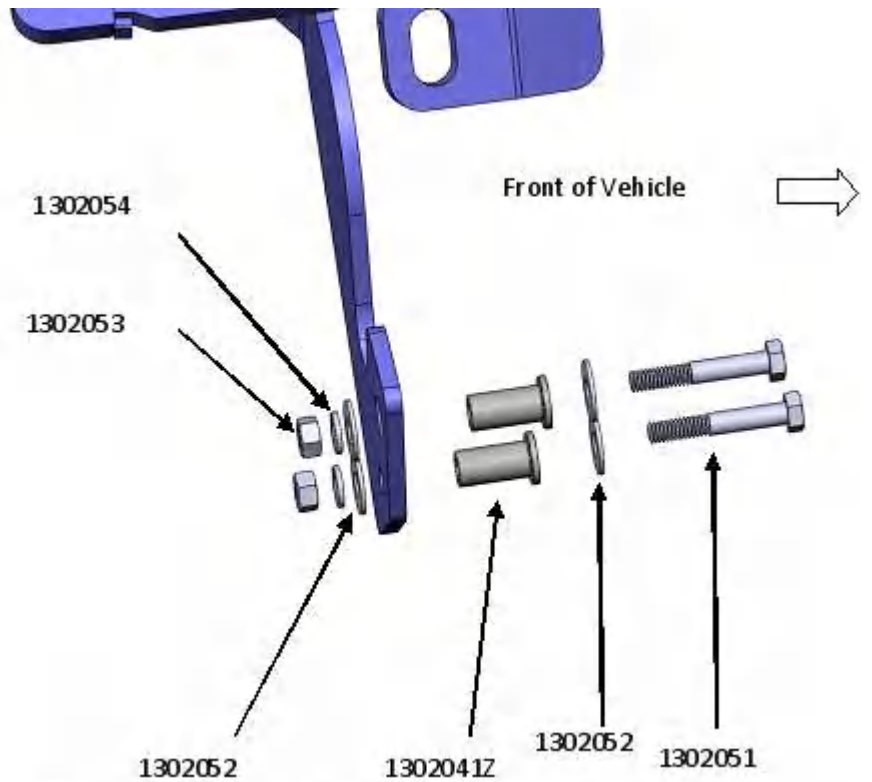

Now using the remaining 1/2" x 5" bolt to secure the last bracket point.



This mounting point is not all that stout, it basically helps eliminate a little bit of twist in the bracket.

You will need to reach up past the cross member underneath the steering box to drop the bolt and washer through the upper frame support.

Note that bolt will pull on an angle.

Then use a flat washer, lock washer and a locknut at the base.

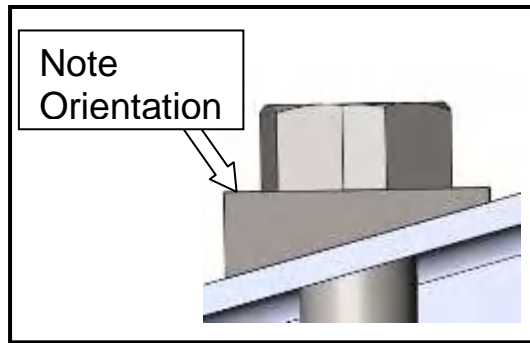

Bolt head to sit Flat on surface

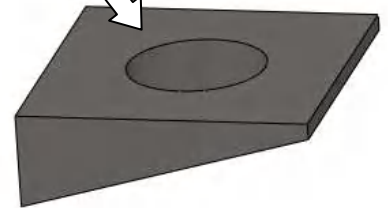

1302047
1302059

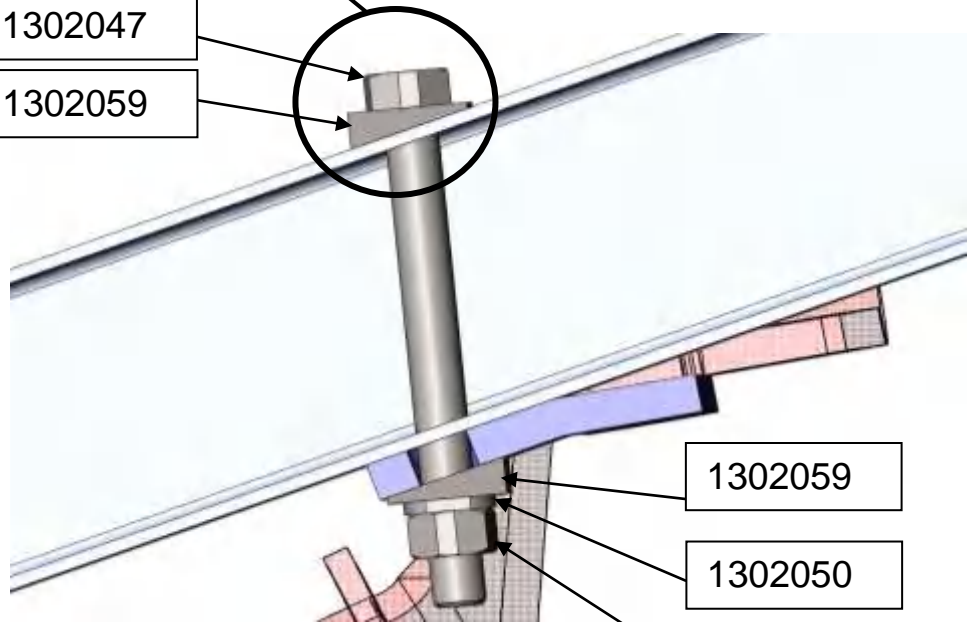

1302059
1302050
1302049



Finally you can now tighten the bracket up. Follow the below order,

Start with the 5/8" bolt (#1302043), torque to 240 ftlbs.

Next torque the 1/2" frame rail bolt (#1302055) to 30 ftlbs. When tightening this bolt the square plate washer will rotate. Use a large crescent wrench to keep in square with the mounting bracket.

Torque the two 5/16 bolts (#1302051) to 20 ft lbs.

Lastly torque the long 1/2" bolt (#1302047) to 30 ftlbs.

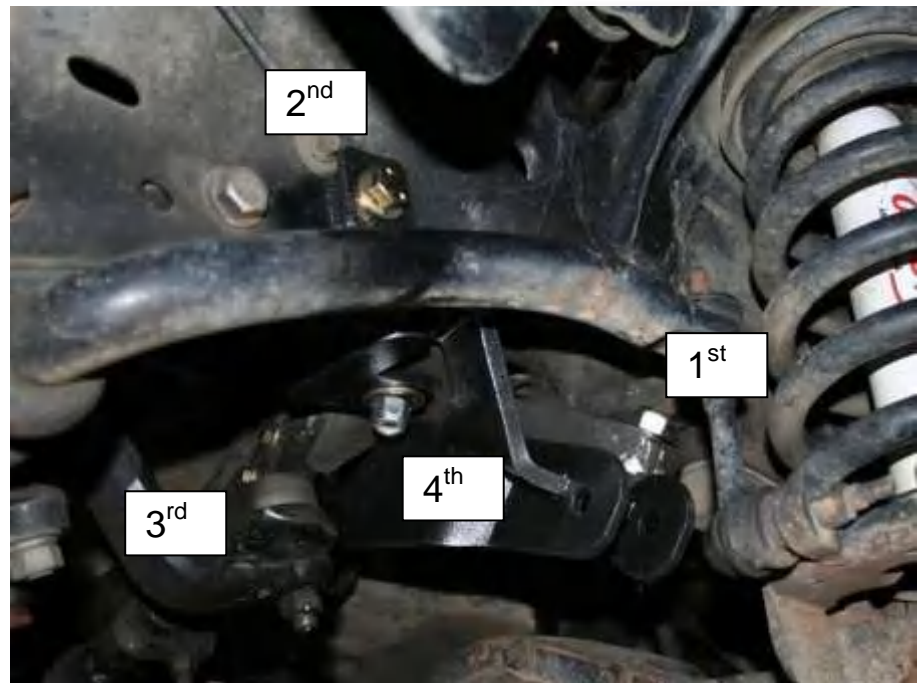
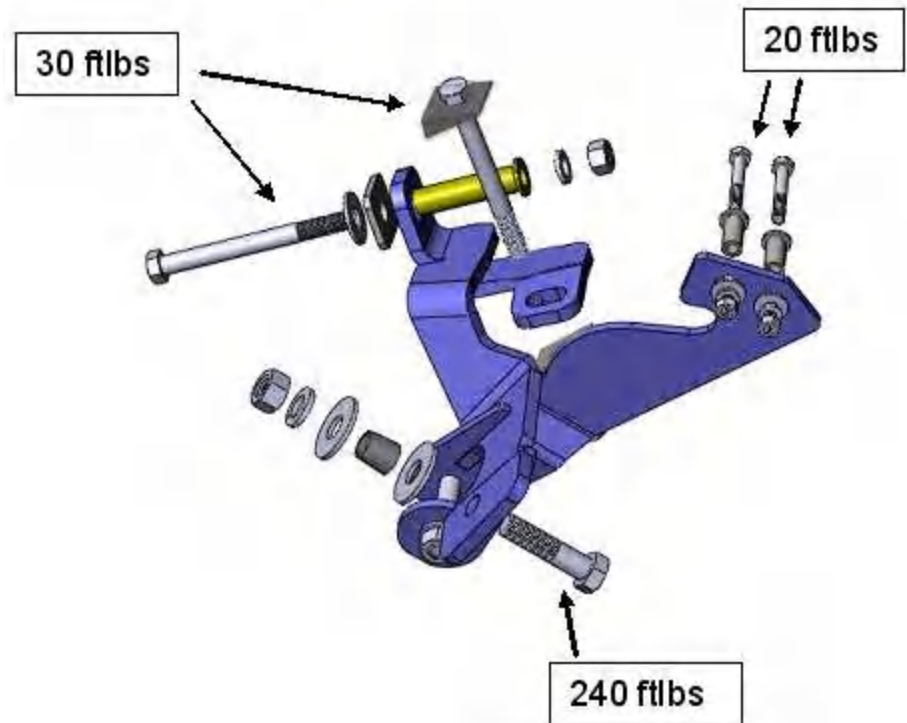

BD Engine Brake Inc.

Plant Address: 33541 MacLure Rd. Abbotsford, BC, Canada V2S 7W2

U.S. Shipping Address: 88-446 Harrison St, Sumas, WA 98295 U.S. Mailing Address: P.O. Box 231, Sumas, WA 98295

Phone: 604-853-6096 | Fax: 604-853-8749 | Internet: www.bd-power.com

On the rear of the cross member you will need to re-secure the brake line.

Choose a hole location that is clear of any moving parts and that is still shielded from road debris.

Drill a 9/32" hole and run the self tapping bolt and brake line bracket into this hole. This in turn should secure the brake line.

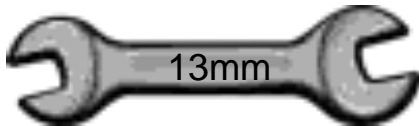

Be sure the brake line does not rub on anything.



Adjustable Track bar Installation

Locate the passenger's side track bar section (#1302030-2F). Thread the 90°grease nipple (#1302056) into thread port on the side of the unit.

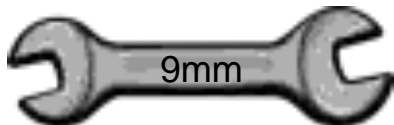

The grease nipple should be threaded so that the nipple face is pointing outwards. Check to ensure you can

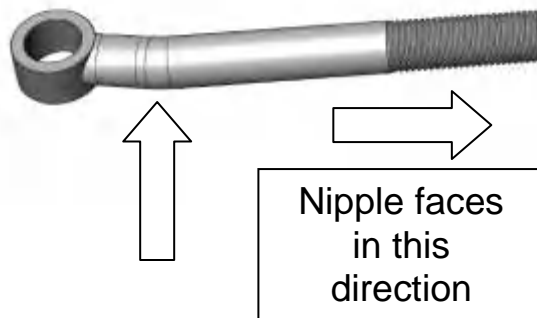

access the nipple with a grease gun. If there is not enough clearance for the grease gun use the supplied 45° nipple (#1302066), installed with the nipple face pointing towards the track bar threads.

Open the bag of poly bushings (#1302033). With the supplied grease rub it all around each half of the bushing (ID and OD). Once fully lubed press the each half of the bushing into the track bar ends. Finally lube the steel sleeve and press into the bushings.



Locate the driver's side track bar section (#1302030-1F). Thread the straight grease nipple (#1302057) into thread port on the side of the unit.

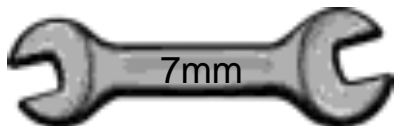

BD Engine Brake Inc.

Plant Address: 33541 MacLure Rd. Abbotsford, BC, Canada V2S 7W2

U.S. Shipping Address: 88-446 Harrison St, Sumas, WA 98295 U.S. Mailing Address: P.O. Box 231, Sumas, WA 98295

Phone: 604-853-6096 | Fax: 604-853-8749 | Internet: www.bd-power.com

Use the remainder of the supplied grease and rub it all around each half of the bushing (ID and OD). Once fully lubed press the each half of the bushing into the track bar ends. Finally lube the steel sleeve and press into the bushings.

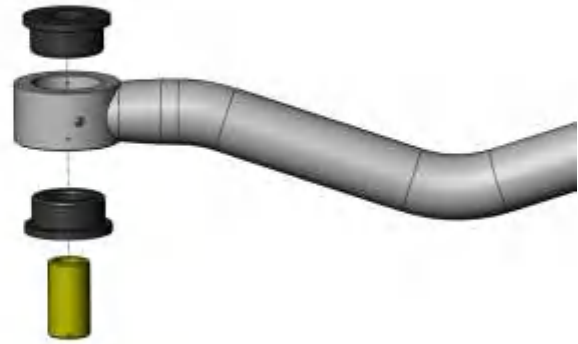

Install the Left Hand Threaded Jam nut (#1302032) on the passenger side track bar section. You will need to thread this all the way to the end.



Install a small amount of anti seize on the threads before threading the nut in place.



BD Engine Brake Inc.

Plant Address: 33541 MacLure Rd. Abbotsford, BC, Canada V2S 7W2

U.S. Shipping Address: 88-446 Harrison St, Sumas, WA 98295 U.S. Mailing Address: P.O. Box 231, Sumas, WA 98295

Phone: 604-853-6096 | Fax: 604-853-8749 | Internet: www.bd-power.com

Install the Right Hand Threaded Jam nut (#1302031) on the driver's side track bar section. You will need to thread this all the way to the end.

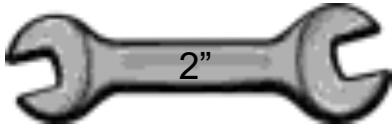

Install a small amount of anti seize on the threads before threading the nut in place.



Thread the passenger side track bar section into the threaded connector (1302030-4).

The passenger side track bar is Left Hand threaded, so you will need to mate these threads to the left hand thread of the connector. The left handed threads should be identified with an "LH".



Locate the factory track bar that you removed earlier, measure the length from bushing center to the approximate center axis of the tapered shaft.

Write this number down.



BD Engine Brake Inc.

Plant Address: 33541 MacLure Rd. Abbotsford, BC, Canada V2S 7W2

U.S. Shipping Address: 88-446 Harrison St, Sumas, WA 98295 U.S. Mailing Address: P.O. Box 231, Sumas, WA 98295

Phone: 604-853-6096 | Fax: 604-853-8749 | Internet: www.bd-power.com

Thread the driver's side section of the track bar into the threaded connector.



Using the length of the factory track bar that you wrote down earlier, Add 1 1/2" to this length.

This will be the new approximate length of the track bar.

Make sure there is an equal number for threads show on each side of the threaded connector.

For example only, if you have 1/2" of thread showing on the passenger side of the threaded connector you should also have 1/2" showing on the driver's side of the threaded connector.



DO NOT EXPOSE MORE THAN 2" OF THREAD FROM EITHER SIDE OF THE THREADED CONNECTOR.

BD Engine Brake Inc.

Plant Address: 33541 MacLure Rd. Abbotsford, BC, Canada V2S 7W2

U.S. Shipping Address: 88-446 Harrison St, Sumas, WA 98295 U.S. Mailing Address: P.O. Box 231, Sumas, WA 98295

Phone: 604-853-6096 | Fax: 604-853-8749 | Internet: www.bd-power.com

Now you can install the track bar into the truck.

Keep in mind that you will need to reuse the factory hardware on the passenger's side only.

Adjust the grease fitting angle so you can access it.

Note that the factory nut has a 'H' bracket attached to it so it can be held in place in front of the axle.

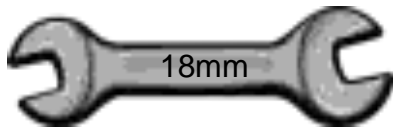

Tighten bolt to 150 ft lbs of torque.



On the driver's side use the 14mm bolt and hardware provided to secure the track bar.

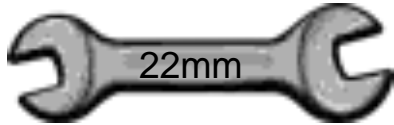

Tighten to 150ftlbs.

Note the grease fitting should face down.

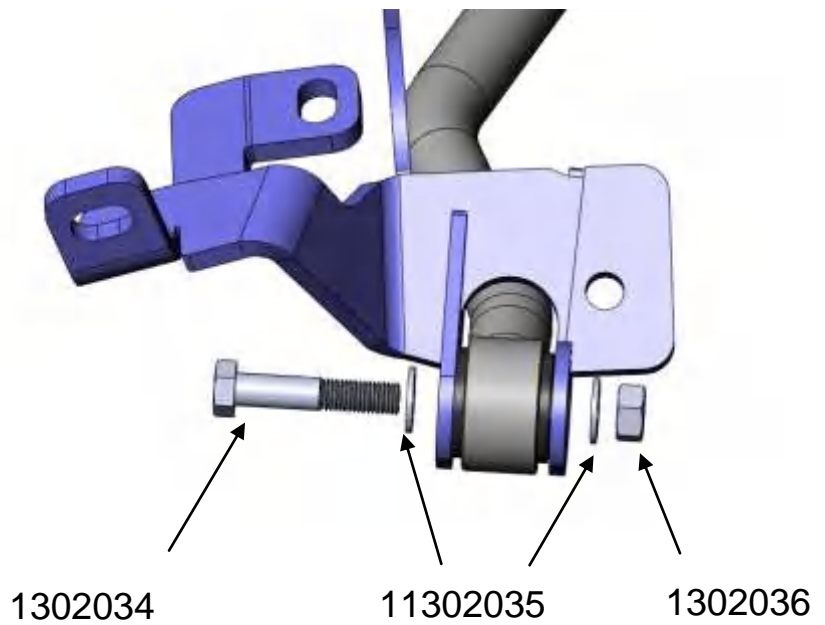

You can now perform an alignment on the front end of the vehicle. Adjust the front axle left and right by turning the threaded connector.

The shorter you make the track bar the more it will pull the front axle towards the driver's side. And vice versa.

Once the alignment is complete tighten the jam nuts to approximately 200 ft lbs of torque.



DO NOT DRIVE THE VEHICLE WITHOUT COMPLETING A PROPER ALIGNMENT.

If you have any technical difficulties, concerns, comments, or complaints, please phone our Technical Support hotline at (800) 887-5030 between 8:30am-5:00pm PST (Pacific Standard Time) Monday to Friday, or post a message on the BD Discussion Forums located at:

<http://forum.bd-power.com/>



Visit our Internet forums at <http://www.dieselpower.com> and share your comments or technical support questions with some of the industry's leading experts in the diesel field.

BD Engine Brake Inc.

Plant Address: 33541 MacLure Rd. Abbotsford, BC, Canada V2S 7W2

U.S. Shipping Address: 88-446 Harrison St, Sumas, WA 98295 U.S. Mailing Address: P.O. Box 231, Sumas, WA 98295

Phone: 604-853-6096 | Fax: 604-853-8749 | Internet: www.bd-power.com